



Wireless Gateway Wireless Repeater

for inverters with SetApp Configuration

V. 1.3

- EN** Quick Installation Guide
- DE** Schnellinstallationsanleitung
- NL** Snelle installatiegids
- FR** Guide d'installation rapide
- IT** Guida rapida all'installazione
- ES** Guía de Instalación Rápida

Apply label
here

- EN** Additional Information
- DE** Zusätzliche Information
- NL** Extra informatie

- FR** Information additionnelle
- IT** Informazioni aggiuntive
- ES** Información adicional

- EN** What's in the Package
- DE** Was ist im Paket enthalten
- NL** Wat zit er in het pakket

- FR** Contenu du package
- IT** Cosa c'è nel pacchetto
- ES** Qué hay en el paquete

- EN** System Setup
- DE** Systemkonfiguration
- NL** Systemconfiguratie

- FR** Installation du système
- IT** Configurazione di sistema
- ES** Configuración del sistema

A

- EN** Remove Inverter Cover
- DE** Entfernen Sie die Wechselrichterabdeckung
- NL** Verwijder de kap van de omvormer
- FR** Retirez le capot de l'onduleur
- IT** Rimuovere il coperchio dell'inverter
- ES** Retirar la tapa del inversor

Antenna installation guide
Installationsanleitung für die Antenne
Installatiehandleiding voor antenne
Guide d'installation de l'antenne
Guida all'installazione dell'antenna
Manual de instalación de la antena
<https://www.solaredge.com/sites/default/files/se-wifi-zigbee-antenna-installation-guide-eng.PDF>

Wireless Gateway installation guide - Complete
Installationsanleitung für das Wireless Gateway
Installatiehandleiding voor Wireless Gateway
Guide d'installation de la Wireless Gateway
Guida all'installazione del Wireless Gateway
Manual de instalación del Wireless Gateway
<https://www.solaredge.com/sites/default/files/se-wireless-gateway-wireless-repeater-installation-guide.pdf>

Discard this product according to local regulations or send it back to SolarEdge.
Entsorgen Sie dieses Produkt entsprechend den örtlichen Vorschriften oder senden Sie es zurück an SolarEdge.
Verwijder dit product in overeenstemming met de lokale regelgeving of stuur het terug naar SolarEdge.
Mette ce produit au rebut conformément à la réglementation en vigueur ou renvoyer celui-ci à SolarEdge.
Smaltire questo prodotto in conformità alle normative locali o restituirlo a SolarEdge.
Deseche este producto según las normativas locales o devuélvalo a SolarEdge.

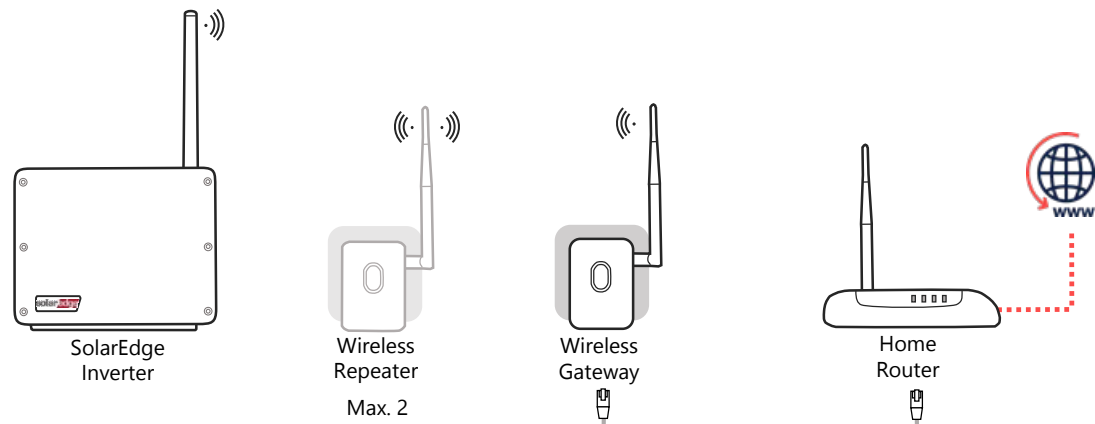
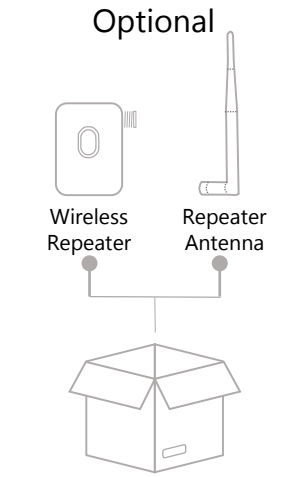
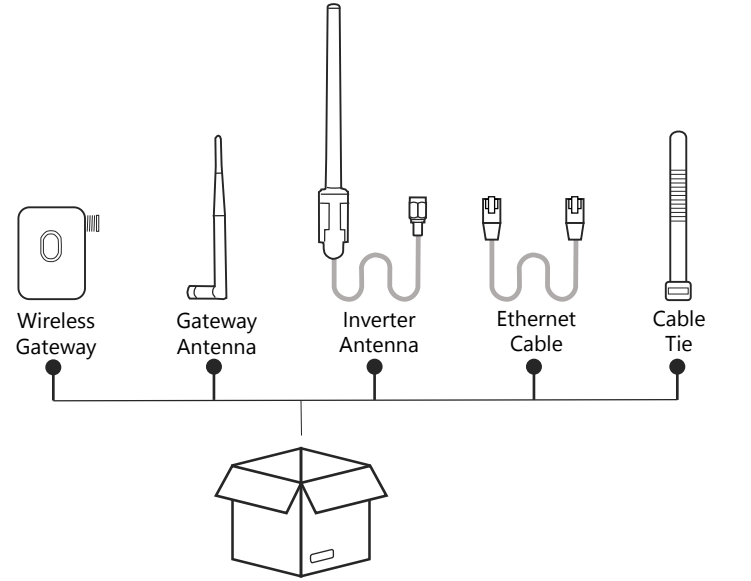

ELECTRICAL SHOCK HAZARD
GEFAHR VON STROMSCHLÄGEN
ELEKTRISCH SCHOKGEVAAR
RISQUE DE CHOC ÉLECTRIQUE
PERICOLO DI SCOSSE ELETTRICHE
PELIGRO DE DESCARGA ELÉCTRICA

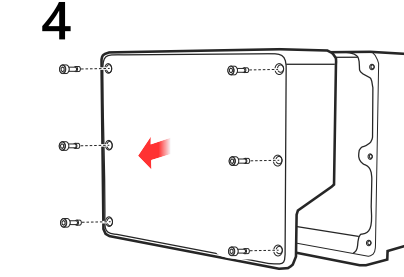
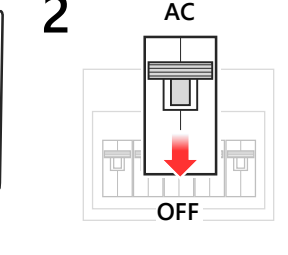
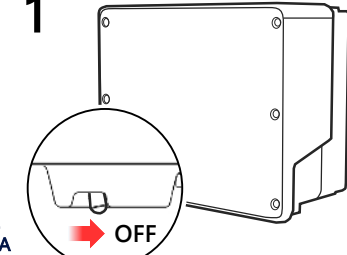

About SolarEdge

SolarEdge is a global leader in smart energy technology. By deploying world-class engineering capabilities and a relentless focus on innovation, we create smart energy products and solutions that power our lives and drive future progress.

 SolarEdge
 @SolarEdgePV
 @SolarEdgePV
 SolarEdgePV
 SolarEdge
 info@solaredge.com

solaredge.com

© SolarEdge Technologies, Ltd.
All rights reserved.
Version: 1.3, Nov. 2020
Subject to change without notice.



B **EN** Install Antenna
DE Installieren Sie die Antenne
NL Antenne installeren

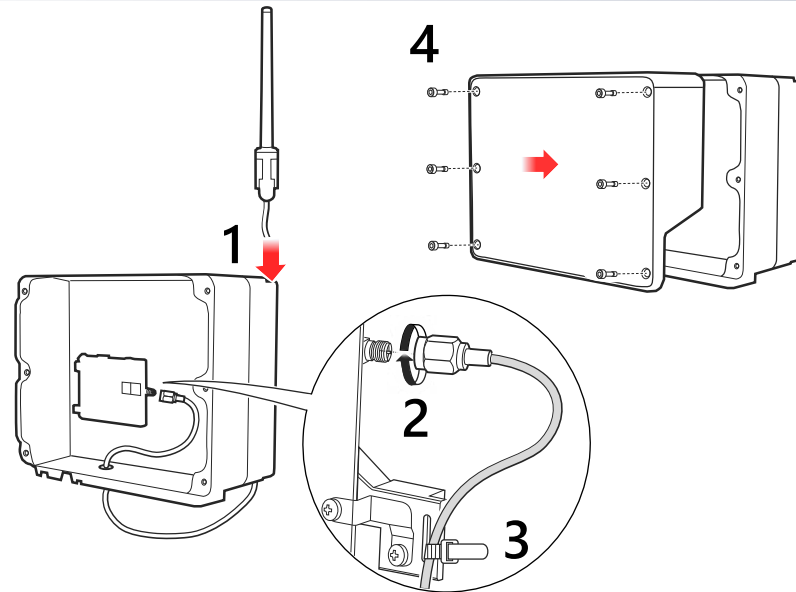

FR Installer l'antenne
IT Installa l'antenna
ES Instalar la Antena

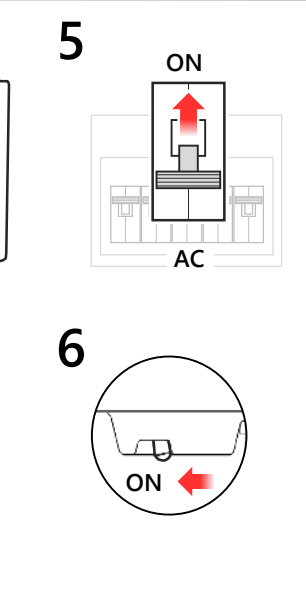

C **EN** Pair with Inverter
DE Mit Wechselrichter koppeln
NL Verbind met omvormer

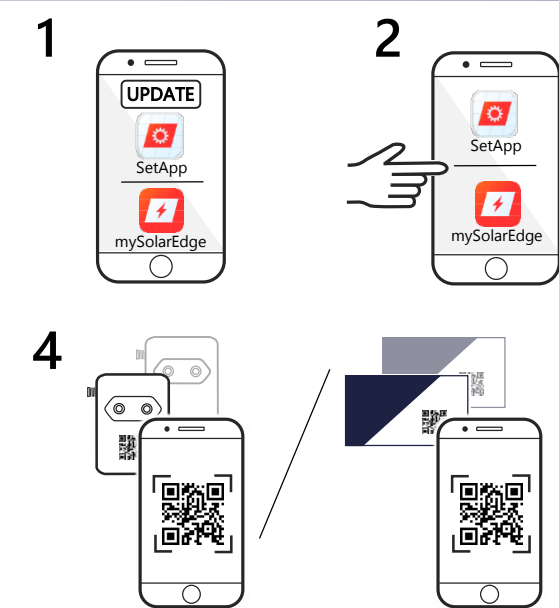

FR Jumeler avec onduleur
IT Abbinare a Inverter
ES Conectar con el inversor

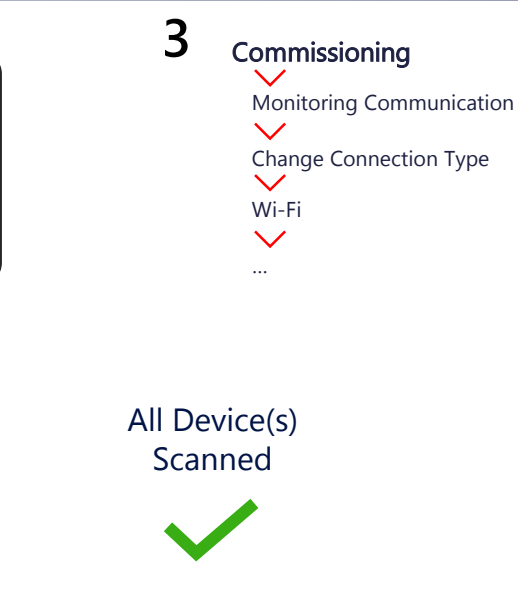

D **EN** Connect Gateway and Repeater
DE Verbinden Sie Gateway und Repeater
NL Verbind Gateway en Repeater

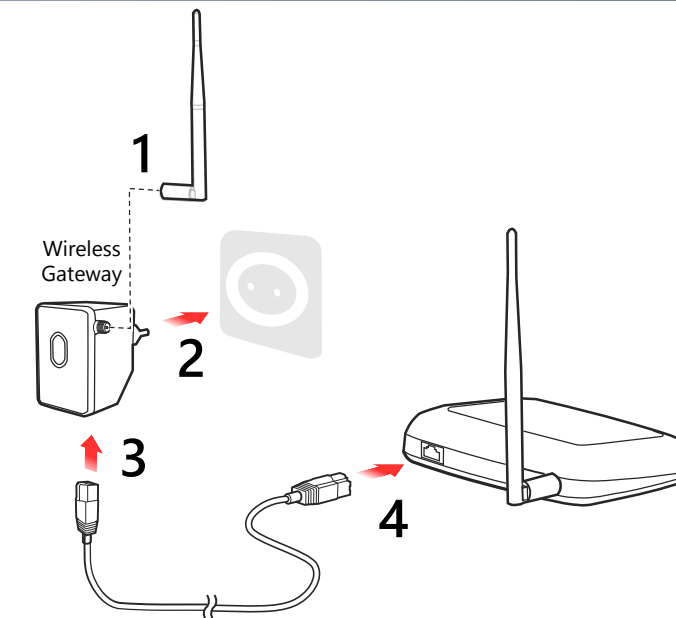

FR Connecter la gateway et le répéteur
IT Collegare gateway e ripetitore
ES Conectar gateway y repetidor

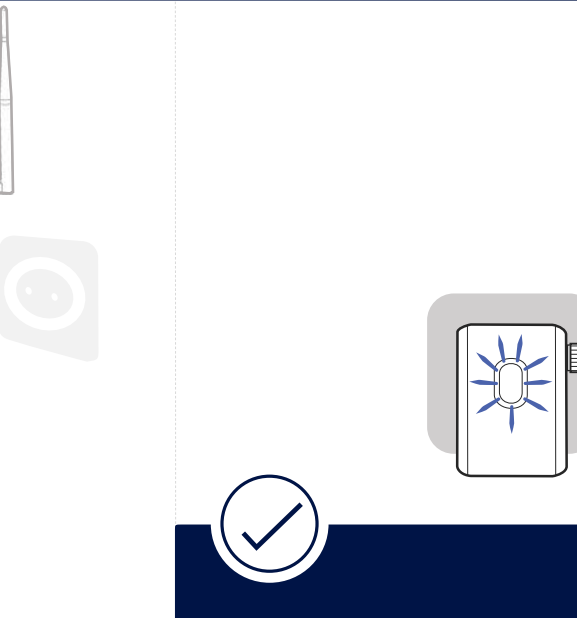

E **EN** Make Sure Blue LED Lights up Continuously
DE Stellen Sie sicher, dass die blaue LED aufleuchtet
NL Zorg ervoor dat de blauwe LED oplicht

FR Assurez-vous que la LED bleue s'allume
IT Accertarsi che il LED blu si accenda
ES Asegurarse de que se encienda el LED azul

LED Indications

Blue	Communication with Monitoring Platform OK
Blue Blinking	No communication with Monitoring Platform
Red	Error
OFF	No power

OK